

High Intensity Blue LED, \varnothing 5 mm Tinted Diffused Package

Color	Type	Technology	Angle of half intensity $\pm\varphi$
Blue	TLHB5400	SiC	25°

Description

The TLHB5400 is a high power silicon carbide LED with a 470 nm peak wavelength.

This new blue LED is housed in a 5 mm tinted diffused plastic package.

Diffusants, tints and optical design are balanced to yield superior light output and wide viewing angle.

Features

- Bright blue light source
- Wide viewing angle ($\varphi = \pm 25^\circ$)
- Typical forward voltage 3 V
- \varnothing 5 mm (T-1 $\frac{3}{4}$) tinted diffused package
- Categorized for luminous intensity
- Low power consumption

Applications

Blue indicators

Blue displays

Blue light source for spectrophotometers, colorimeters, blood analysers, tissue analysers

TLHB5400

Absolute Maximum Ratings

$T_{amb} = 25^{\circ}\text{C}$, unless otherwise specified

Blue (TLHB5400)

Parameter	Test Conditions	Type	Symbol	Value	Unit
Reverse voltage			V_R	6	V
DC forward current			I_F	60	mA
Power dissipation	$T_{amb} \leq 25^{\circ}\text{C}$		P_V	200	mW
Junction temperature			T_j	100	$^{\circ}\text{C}$
Operating temperature range			T_{amb}	-20 to +80	$^{\circ}\text{C}$
Storage temperature range			T_{stg}	-55 to +100	$^{\circ}\text{C}$
Soldering temperature	$t \leq 5$ s, 2 mm from body		T_{sd}	260	$^{\circ}\text{C}$
Thermal resistance junction/ambient			R_{thJA}	350	K/W

Optical and Electrical Characteristics

$T_{amb} = 25^{\circ}\text{C}$, unless otherwise specified

Blue (TLHB5400)

Parameter	Test Conditions	Type	Symbol	Min	Typ	Max	Unit
Luminous intensity	$I_F = 20$ mA, $I_{Vmin}/I_{Vmax} \geq 0.5$		I_V	0.63	1.5		mcd
Luminous flux	$I_F = 20$ mA		ϕ_V		2		mlm
Dominant wavelength	$I_F = 50$ mA		λ_d		470		nm
Spectral line half width	$I_F = 50$ mA		$\Delta\lambda$		70		nm
Angle of half intensity	$I_F = 20$ mA		φ		± 25		deg
Forward voltage	$I_F = 20$ mA		V_F		3.1	3.5	V
Reverse voltage	$I_R = 10$ μA		V_R	6	60		V

Typical Characteristics ($T_{amb} = 25^{\circ}\text{C}$, unless otherwise specified)

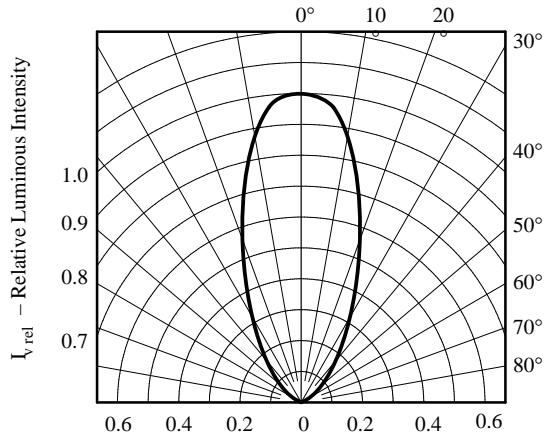

95 10041

Figure 1. Rel. Luminous Intensity vs. Angular Displacement

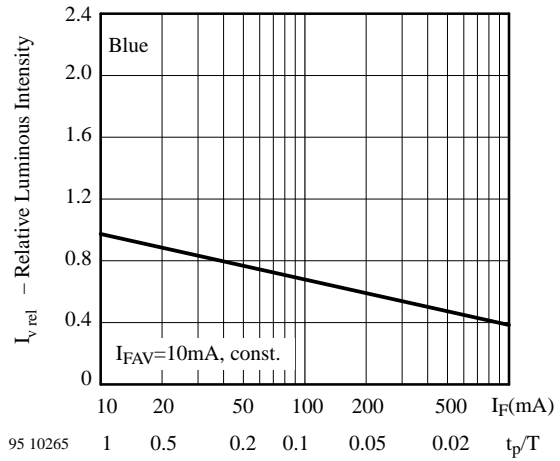

95 10265

Figure 4. Rel. Lumin. Intensity vs. Forw. Current/Duty Cycle

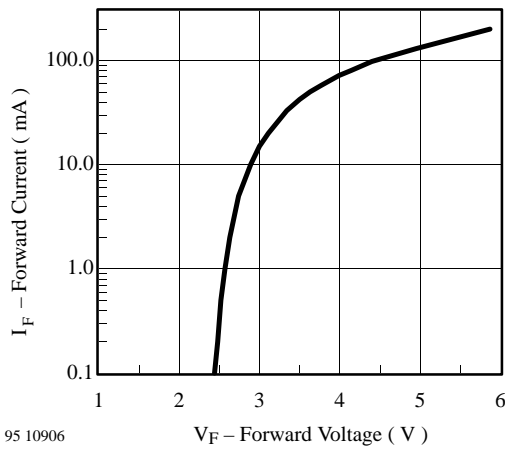

95 10906

Figure 2. Forward Current vs. Forward Voltage

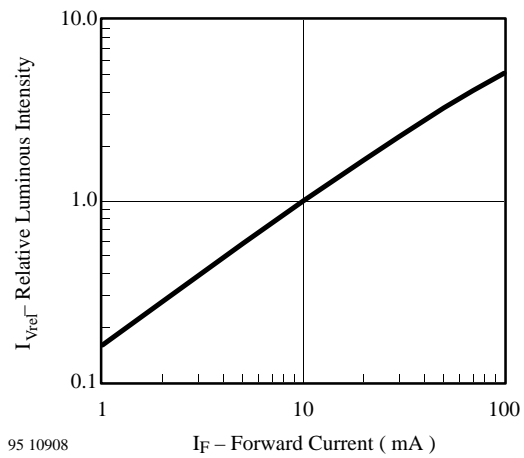

95 10908

Figure 5. Relative Luminous Intensity vs. Forward Current

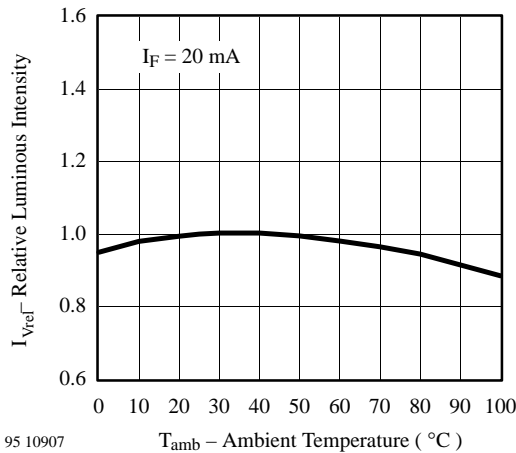

95 10907

Figure 3. Rel. Luminous Intensity vs. Ambient Temperature

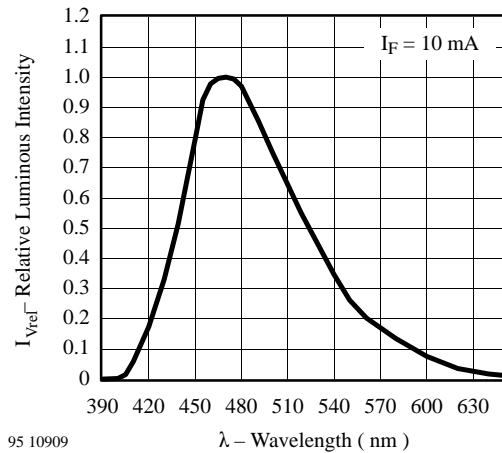

95 10909

Figure 6. Relative Luminous Intensity vs. Wavelength

TLHB5400

TEMIC

TELEFUNKEN Semiconductors

Dimensions in mm

95 10916

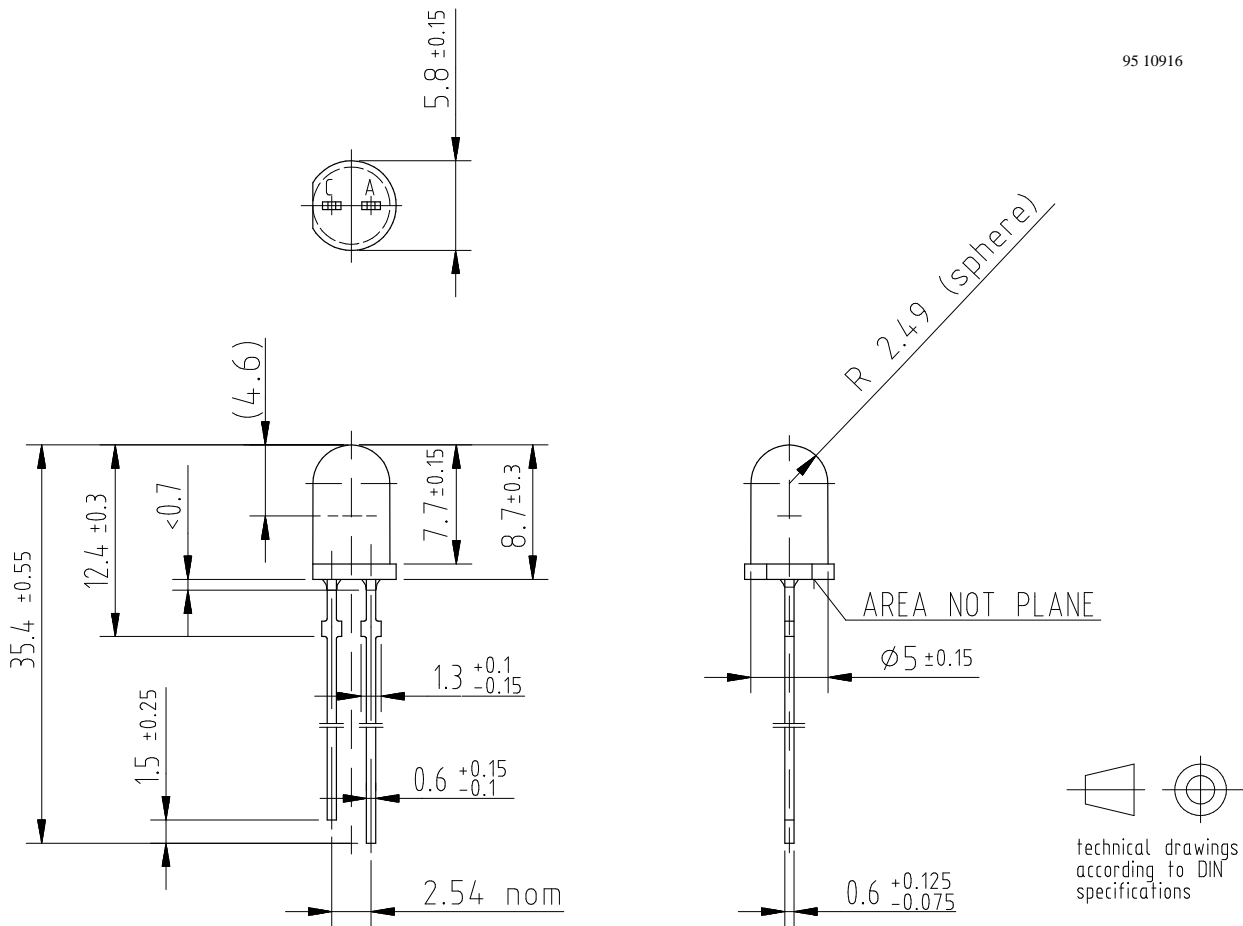

Ozone Depleting Substances Policy Statement

It is the policy of **TEMIC TELEFUNKEN microelectronic GmbH** to

1. Meet all present and future national and international statutory requirements.
2. Regularly and continuously improve the performance of our products, processes, distribution and operating systems with respect to their impact on the health and safety of our employees and the public, as well as their impact on the environment.

It is particular concern to control or eliminate releases of those substances into the atmosphere which are known as ozone depleting substances (ODSs).

The Montreal Protocol (1987) and its London Amendments (1990) intend to severely restrict the use of ODSs and forbid their use within the next ten years. Various national and international initiatives are pressing for an earlier ban on these substances.

TEMIC TELEFUNKEN microelectronic GmbH semiconductor division has been able to use its policy of continuous improvements to eliminate the use of ODSs listed in the following documents.

1. Annex A, B and list of transitional substances of the Montreal Protocol and the London Amendments respectively
2. Class I and II ozone depleting substances in the Clean Air Act Amendments of 1990 by the Environmental Protection Agency (EPA) in the USA
3. Council Decision 88/540/EEC and 91/690/EEC Annex A, B and C (transitional substances) respectively.

TEMIC can certify that our semiconductors are not manufactured with ozone depleting substances and do not contain such substances.

We reserve the right to make changes to improve technical design and may do so without further notice.

Parameters can vary in different applications. All operating parameters must be validated for each customer application by the customer. Should the buyer use TEMIC products for any unintended or unauthorized application, the buyer shall indemnify TEMIC against all claims, costs, damages, and expenses, arising out of, directly or indirectly, any claim of personal damage, injury or death associated with such unintended or unauthorized use.

TEMIC TELEFUNKEN microelectronic GmbH, P.O.B. 3535, D-74025 Heilbronn, Germany
Telephone: 49 (0)7131 67 2831, Fax number: 49 (0)7131 67 2423